

Allegro



TIFFIN MOTORHOMES

ALLEGRO[®] 2010

20
10



TIFFIN MOTORHOMES

WHEREVER YOU GO, WE GO.



SUNLIT SAND EXTERIOR



A GREAT START TO YOUR JOURNEY.

Ready to get under way? So is the Allegro. And if you're new to motor homes, it may be exactly the right start for you. It's easy to drive and maneuver and affordably priced, yet Allegro's engineering and construction are pure Tiffin. When you join our family of owners, you're part of a unique ownership experience. Hundreds of Allegro owners come back to visit us in Red Bay every year, and Bob Tiffin is glad to talk with them when they do. Our industry-leading warranties include 10 years for structural integrity and 5 years for lamination. The 2010 Allegro comes in five exterior colors, including Rocky Mountain Brown, a new lighter color suggested by owners. A sleeper sofa and the option of a floor plan with bunk beds let you bring everyone along for the ride.

20
10
Allegro





THE ROAD IS READY. SO ARE YOU.

COCKPIT

Slip into the optional Halo leather driver's seat, and watch a great country come to life before your eyes. Allegro is the legend Tiffin was built on, and today it's better than ever. Thirty years of satisfied owners will tell you that the engineering that goes into an Allegro makes it one of the most reliable, comfortable motor homes on the road. Because we know you'll want to take your life with you, there's ample under-coach storage with bins for your luggage and tailgating equipment. Flat screen TVs and the optional surround sound home theater system may be even more impressive than what you have at home.



ACTUALLY, YOU CAN ENGINEER HAPPINESS.

Tiffin engineers employ innovative construction techniques, which deliver superior resilience and stability. And we use high-quality components, such as laminated sidewalls and floors to provide ultimate durability and sturdiness on the road. These safety steps ensure that our owners enjoy lasting value, year after year. For a complete list of specifications and options, please visit tiffinmotorhomes.com

CONSTRUCTION SPECIFICATIONS

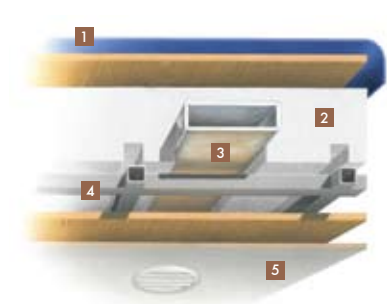

ROOF

1. One-piece, moisture resistant molded fiberglass roof cap provides insulation and strength and prevents water intrusion
2. 5 1/2" formed insulation
3. Quiet Air Cooling System with return air and foil-wrapped cooling exhaust ducts
4. Durable, tubular aluminum roof skeleton
5. Easy-to-clean soft touch vinyl ceiling panel

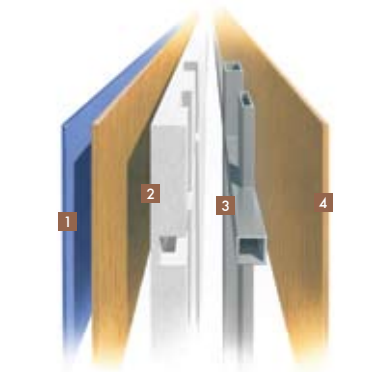

SIDEWALL

1. Gel-coat fiberglass outside wall panel
2. High-performance thermal insulation
3. Durable, yet lightweight, tubular aluminum wall skeleton
4. Decorative inside wall panel

All sidewalls are approximately 2" thick.

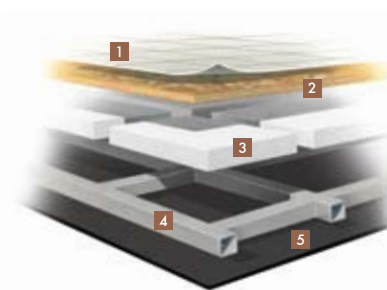

FLOOR

1. Vinyl tile floor bonded to high-impact oriented strand board
2. High-level engineered oriented strand board
3. High-performance thermal insulation
4. Durable, tubular steel floor skeleton
5. Woven moisture barrier material

STRUCTURAL

STANDARD EQUIPMENT ON ALL MODELS:

- Laminated Floor, Sidewall & Roof
- Steel / Aluminum Reinforced Structure
- One-piece Molded Fiberglass Roof Cap

EXTERIOR

STANDARD EQUIPMENT ON ALL MODELS:

- Fiberglass Front & Rear Caps
- Tinted One-piece Windshield
- 5.5 kw Onan® Generator (Gas Engine Only)
- Two 13,500 BTU High Profile Roof Coleman A/Cs (High Efficiency)
- Quiet A/C Roof-ducted System
- Double Electric Step
- 1/4" Thick Single Pane Windows
- Horizontal Mounted Wipers
- Black Holding Tank Flush System
- Exterior Rinse Hose / Shower
- Back-up Monitor
- Heated Power Mirrors
- BASF Full Body Paint with Front Cap Protective Film
- Exterior Patio Light
- Power Patio Awning
- Slide-out Awning(s)
- Hydraulic Automatic Leveling Jacks
- 110 V Exterior Receptacle
- Undercoating
- Roof Ladder
- Convenient Access Doors with Gas Shocks
- Ridged Long-life Storage Boxes
- Single Handle Lockable Storage Door Latches
- Heated Water & Holding Tank Compartments
- Two 6 V Auxiliary Batteries
- Park Telephone Ready
- Digital TV Antenna
- Cable Ready TV
- 50 Amp Service
- External Tripod Satellite Hook-up
- Side-view Cameras Activated by Turn Signals

AVAILABLE OPTIONS:

	30 DA	32 BA	34 TGA	35 QBA
6.0 kw Onan® Diesel Generator* (FRED Chassis Only)	NA	S*	S*	S*
7.0 kw Onan® Generator (Gas Engine Only)	O	O	O	O
Automatic Satellite	O	O	O	O
One 15,000 BTU High Profile Roof A/C with Heat Pump	O	O	O	O
CB Antenna	O	O	O	O

*Standard on all FRED chassis models only

DRIVER'S COMPARTMENT

STANDARD EQUIPMENT ON ALL MODELS:

- Entry Floor Light
- Step Switch & 12 V Disconnect Switch
- Non-power Cloth Driver & Passenger Seats
- Power Windshield Solar / Privacy Shade
- Lighted Instrument Panel
- Single CD Player & AM/FM Stereo
- Passenger Slide Tray / Computer Drawer
- Fire Extinguisher
- 12 V Dash Receptacle
- Tilt Steering Wheel
- Dual Dash Fans
- Snack / Beverage Tray

AVAILABLE OPTIONS:

	30 DA	32 BA	34 TGA	35 QBA
Power Cloth Driver & Passenger Seats	O	O	O	O
Power Halo Leather Driver & Passenger Seats	O	O	O	O
Driver's Door with Power Window	O	O	O	O
26" LCD Front Overhead TV	S	S	O	O

TECHNICAL SPECIFICATIONS

AUTOMOTIVE

STANDARD EQUIPMENT ON ALL MODELS:

• TorqShift® 5-speed Automatic Overdrive with Tow/Haul Mode (Ford)

• 1000 MH Series 6-speed Automatic Allison Transmission with Overdrive (Workhorse)

• Emergency Start Switch

• Cruise Control

FORD CHASSIS	30 DA	32 BA	34 TGA	35 QBA
Engine - 362 HP	6.8 L V10	6.8 L V10	6.8 L V10	6.8 L V10
Torque (Lb.-Ft. Max. Net)	457 @ 3250	457 @ 3250	457 @ 3250	457 @ 3250
GVWR	22,000 Lb.	22,000 Lb.	22,000 Lb.	22,000 Lb.
GAWR - Front	7,500 Lb.	7,500 Lb.	7,500 Lb.	7,500 Lb.
GAWR - Rear	14,500 Lb.	14,500 Lb.	14,500 Lb.	14,500 Lb.
GCWR	26,000 Lb.	26,000 Lb.	26,000 Lb.	26,000 Lb.
Wheel Base	208"	228"	242"	242"
Tire Size	235/80R22.5-GXRV	235/80R22.5-GXRV	235/80R22.5-GXRV	235/80R22.5-GXRV
Fuel Tank (Gallons)	75	75	75	75
Alternator Amps	130	130	130	130
Trailer Hitch Capacity	5,000 Lb.	5,000 Lb.	5,000 Lb.	5,000 Lb.

WORKHORSE CHASSIS	30 DA	32 BA	34 TGA	35 QBA
Engine - 340 HP	8.1 L V8	8.1 L V8	8.1 L V8	8.1 L V8
Torque (Lb.-Ft. Max. Net)	455 @ 4200	455 @ 4200	455 @ 4200	455 @ 4200
GVWR	22,000 Lb.	22,000 Lb.	22,000 Lb.	22,000 Lb.
GAWR - Front	8,000 Lb.	8,000 Lb.	8,000 Lb.	8,000 Lb.
GAWR - Rear	14,500 Lb.	14,500 Lb.	14,500 Lb.	14,500 Lb.
GCWR	26,000 Lb.	26,000 Lb.	26,000 Lb.	26,000 Lb.
Wheel Base	208"	228"	242"	242"
Tire Size	235/80R22.5	235/80R22.5	235/80R22.5	235/80R22.5
Fuel Tank (Gallons)	75	75	75	75
Alternator Amps	145	145	145	145
Trailer Hitch Capacity	5,000 Lb.	5,000 Lb.	5,000 Lb.	5,000 Lb.

FREIGHTLINER FRONT ENGINE DIESEL CHASSIS	30 DA	32 BA	34 TGA	35 QBA
Engine - 300 HP	NA	Cummins	Cummins	Cummins
Torque (Lb.-Ft. Max. Net)	NA	620 @ 1500	620 @ 1500	620 @ 1500
GVWR	NA	24,000 Lb.	24,000 Lb.	24,000 Lb.
GAWR - Front	NA	9,000 Lb.	9,000 Lb.	9,000 Lb.
GAWR - Rear	NA	15,000 Lb.	15,000 Lb.	15,000 Lb.
GCWR	NA	26,000 Lb.	26,000 Lb.	26,000 Lb.
Wheel Base	NA	228"	242"	242"
Tire Size	NA	235/80R22.5	235/80R22.5	235/80R22.5
Fuel Tank (Gallons)	NA	80	80	80
Alternator Amps	NA	160	160	160
Allison Transmission	NA	S	S	S
Trailer Hitch Capacity	NA	5,000 Lb.	5,000 Lb.	5,000 Lb.

OVERALL	30 DA	32 BA	34 TGA	35 QBA
Overall Length (Approximate)	31' 3"	32' 10"	34' 10"	35' 10"
Overall Height with Roof Air (Maximum)	12' 7"	12' 7"	12' 7"	12' 7"
Interior Height	83.5"	83.5"	83.5"	83.5"
Overall Width	101"	101"	101"	101"
Interior Width	96"	96"	96"	96"
Fresh Water (Gallons)	53	53	53	80
Black Water (Gallons)	35	35	35	45
Grey Water (Gallons)	70	70	70	70
LPG Tank (Gallons; can only be filled to 80% capacity)	24	24	24	24
Minimum Garage Height	13'	13'	13'	13'
Basement Storage (Cubic Feet - Approximate)	57	67	69	69



BROADEN YOUR HORIZONS.
AND YOUR LIVING SPACE.



LIVING AREAS

Our designers kept the Allegro interior simple and elegant, so you can accessorize it to your tastes. Color themes Estate, Key Largo, and Platinum are all new for 2010. You'll find standard Formica® countertops and solid wood cabinet fascias with stacked drawers under the stove for cookware storage. Entertaining's a pleasure, and cleanup is a breeze thanks to the Scotchgard® treated fabrics and carpets, and an optional vacuum cleaner system. Privacy is a priority, with a separate closed-off lavatory and the option of a floor plan with a separate shower area. The tile floors are elegant, durable, and easy to clean. The bedroom features an innerspring queen mattress, spacious wardrobe with built-in drawers, as well as dual nightstands and an optional 26" TV.



ESTATE INTERIOR
MEDIUM ALDERWOOD CABINETS
Interior Decor Not Included

CHOOSE YOUR BEAUTIFUL.

Engineering makes a Tiffin reliable, but design is what makes it unique. From cabinets crafted in our own cabinet shop to the designer-chosen finishes, here's everything you need to make your Allegro your own. For a complete list of options and specifications, please visit tiffinmotorhomes.com

INTERIOR OPTIONS



Cherry Bark

Medium Alderwood

Carpet

ESTATE



Bedroom/
Bedroom Accent



Sofa

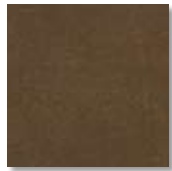

Living Area Accent



Dinette

KEY LARGO



Bedroom/
Bedroom Accent



Sofa



Living Area Accent



Dinette

PLATINUM



Bedroom/
Bedroom Accent



Sofa



Living Area Accent



Dinette

Cabinet doors are made of solid wood, and all cabinet finishes are available in combination with any fabric scheme.

All options may not be available in every model.

Specifications and standard or optional equipment are subject to change without notice or obligation.

INTERIOR SPECIFICATIONS STANDARD EQUIPMENT ON ALL MODELS:

LIVING AREA / DINETTE

- Booth Dinette with Large Pullout Storage Drawers
- Cloth DE Sofa Bed
- Swivel Chair
- Decorative Wall Hanging

AVAILABLE OPTIONS:	30 DA	32 BA	34 TGA	35 QBA
Cloth Flex-o Bed Sleeper Sofa	NA	O	O	O
Halo Leather Flex-o Bed Sofa	NA	O	O	O
Freestanding Dinette with Cabinets	NA	O	O	O
32" LCD TV in Entertainment Center	NA	NA	S	S
Home Theater Surround Sound System (Includes DVD Player)	O	O	O	O
DVD Player	O	O	O	O

KITCHEN

- Single Lever Satin Nickel Sink Faucet
- Solid Surface Countertop Edging
- 3-burner Cooktop with Gas Oven
- 8 Cubic Foot Refrigerator
- Double Bowl Kitchen Sink
- Solid Surface Backsplashes
- Microwave with Exterior Venting

AVAILABLE OPTIONS:	30 DA	32 BA	34 TGA	35 QBA
Convection / Microwave	O	O	O	O
Icemaker in Refrigerator	O	O	O	O
Solid Wood Refrigerator Panels	O	O	O	O

BATH

- Medicine Cabinet
- Skylight in Shower
- Satin Nickel Vanity Faucet
- Fiberglass Molded Shower
- Fantastic® Fan (Water Closet Only)

BEDROOM

- Wardrobe with Automatic Light
- Innerspring Queen Mattress (60" x 80")
- Wall-to-wall Carpeting
- Bed Comforter with Throw Pillows
- Solar / Private RollEase® Shades

AVAILABLE OPTIONS:	30 DA	32 BA	34 TGA	35 QBA
26" LCD TV	O	O	O	O
Bunk Beds (30" x 72") with Bunk Ladder	NA	NA	NA	S
DVD Monitors in Bunk	NA	NA	NA	O
Tile Flooring In Bedroom	O	O	O	O

GENERAL INTERIOR

- Medium Alderwood Solid Cabinet Doors & Drawer Fronts
- Solid Wood Cabinet Fascias
- Wall-to-wall Vinyl Tile Flooring in Living Room, Kitchen & Bath
- Solar / Privacy RollEase® Shades
- Ball Bearing Drawer Slides
- Scotchgard® Treated Carpet & Fabrics
- Power Roof Vents
- Soft Touch Vinyl Ceiling
- Raised Panel Hardwood Cabinet Doors
- LPG Leak Detector
- Tank Level Monitor System
- Smoke Detector
- 6-gallon DSI Gas / Electric Water Heater
- Compartment Door with Single Point Latch
- Carbon Monoxide Detector

AVAILABLE OPTIONS:	30 DA	32 BA	34 TGA	35 QBA
Central Vacuum Cleaner	O	O	O	O
One 30,000 BTU Ducted Furnace	S	NA	NA	NA
Two 30,000 BTU Ducted Furnaces	NA	NA	S	S
One 35,000 BTU Ducted Furnace	NA	S	NA	NA
Cherry Bark Solid Cabinet Doors & Drawer Fronts	O	O	O	O

30 DA

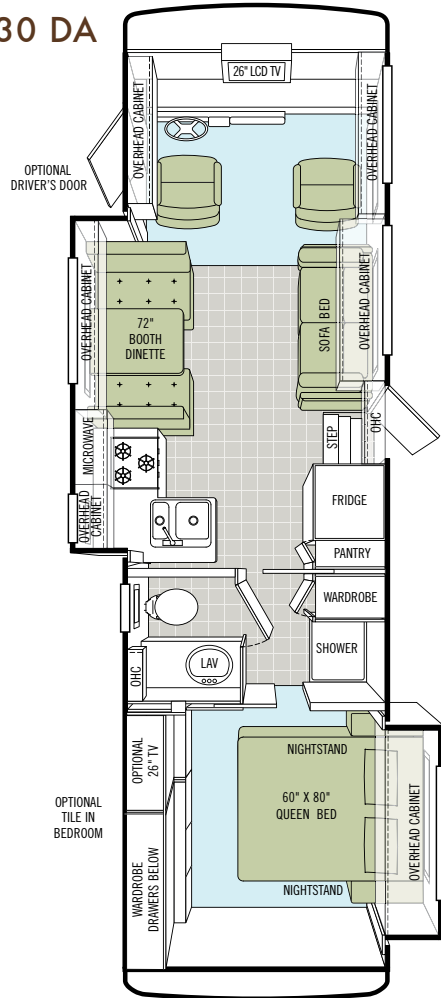

32 BA

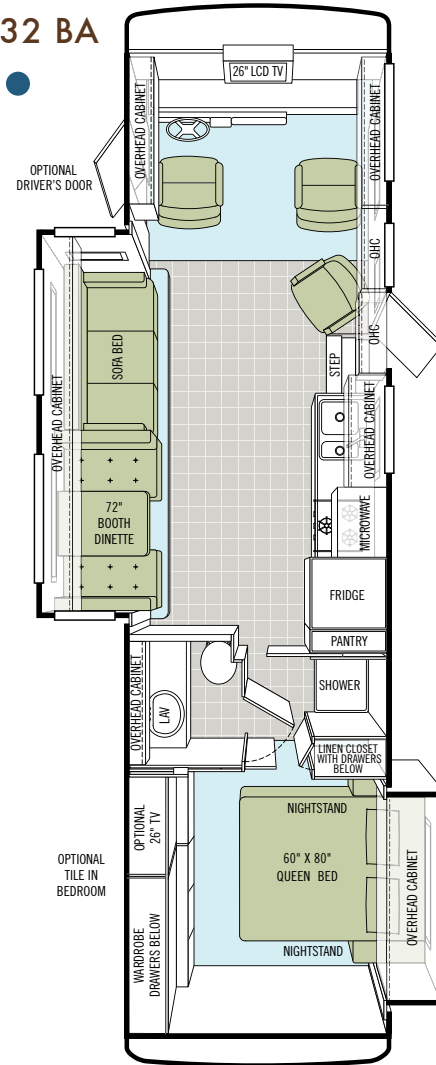

34 TGA

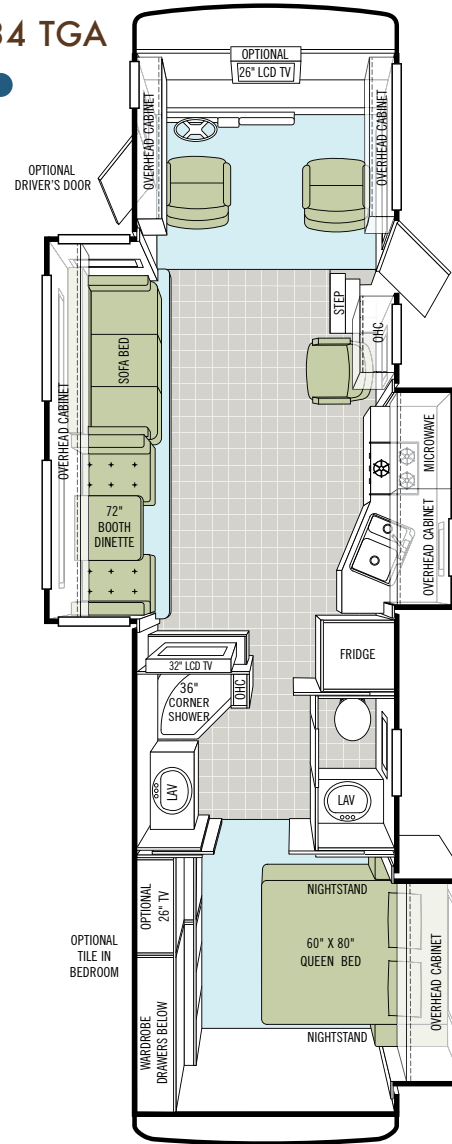

35 QBA

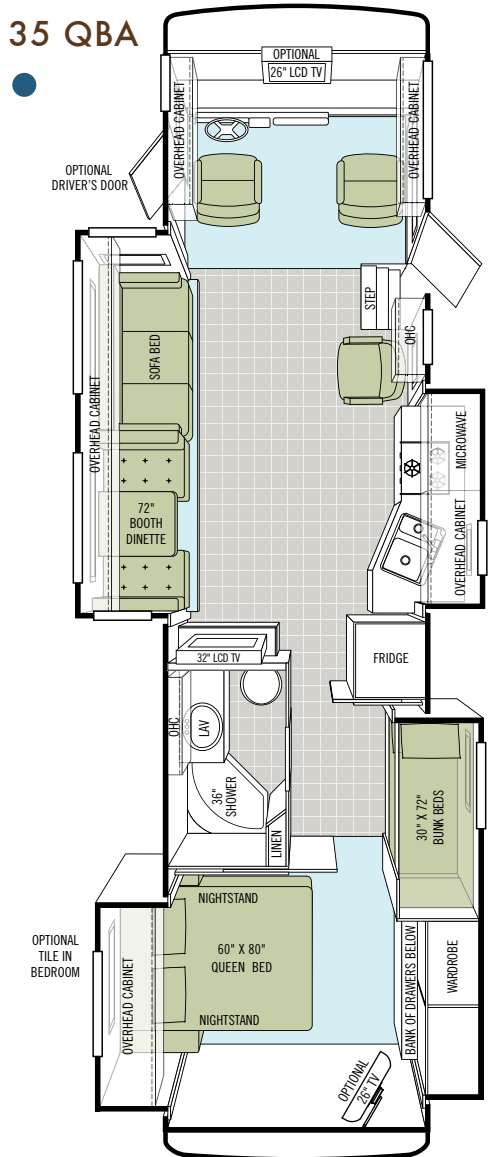

OPTION KEY

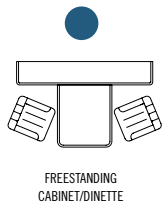

WHEREVER YOU GO, WE GO.

These days, that simple promise carries more weight than ever. In a time when some companies have struggled, a manufacturer who stands behind the product they build has never been more important. We've never been prouder of the strength of our company, our warranty and service plan (still the best in the motor home industry), and most importantly, the trust we've built with a very special group of motor home owners. We understand the richness that travel brings to your life, and our family is so proud of the relationship we have with yours. You are the reason we do what we do and why we never stop working to build a better Tiffin experience for you.

WARRANTIES THAT GO WHEREVER YOU GO.

10-YEAR LIMITED UNITIZED CONSTRUCTION WARRANTY - The structural integrity of the entire coach is guaranteed for the next 10 years. Warranty includes wall separation and inner frame weakness.

5-YEAR LIMITED LAMINATION WARRANTY - We guarantee against all exterior fiberglass delamination or wall separation.



Start your journey by visiting our website. We'd love to hear from you, so give us a call, send us a postcard or stop by our office the next time you pass by Red Bay. Because remember, wherever you go, we go.

Sincerely,

A handwritten signature in black ink that reads "Bob Tiffin". The signature is written in a cursive style with a large, sweeping flourish at the end.



TIFFIN MOTORHOMES

WHEREVER YOU GO, WE GO.

105 2nd Street NW, Red Bay, AL 35582
call 256.356.8661 fax 256.356.8219 or visit tiffinmotorhomes.com
FOR PARTS AND SERVICE CALL 256.356.0261

The following names are registered trademarks of Tiffin Motorhomes: Open Road®, Phaeton®, Allegro®, Allegro RED®, Allegro Bay®, Allegro Bus®, Zephyr®, Roughing It Smoothly®, and Pusher®.

DEALER